

1.* Outside O.D. Diameter

4. Gasket

3. End Cap

1. I.D. Inside Diameter

2. Outer Liner

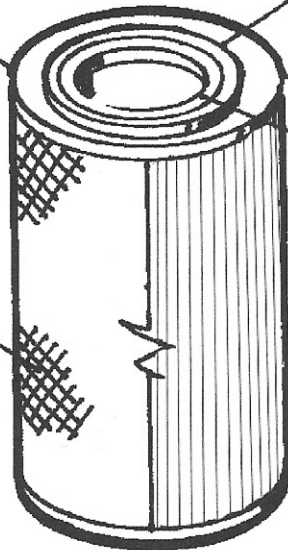

5. Round Flange

5. Square Flange

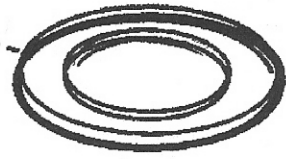
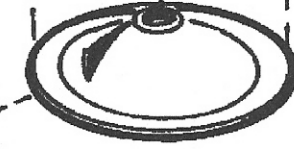
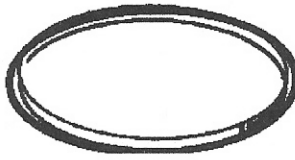
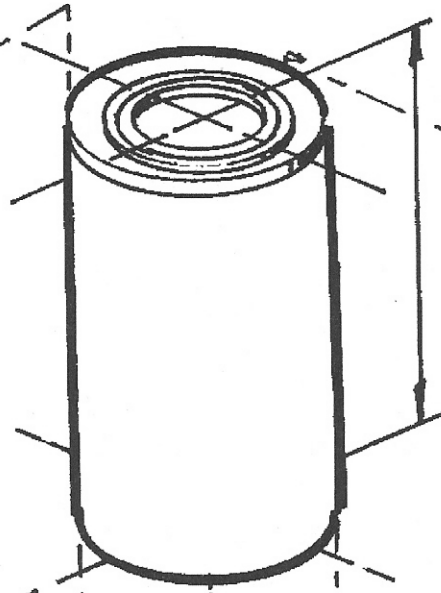
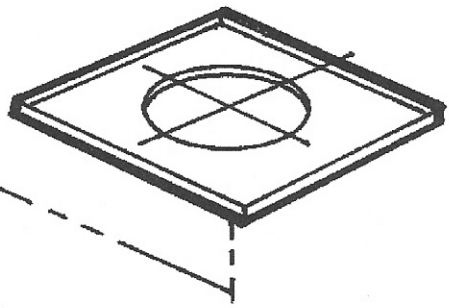
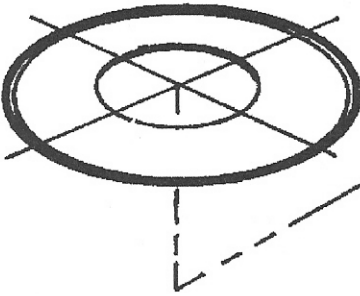

3. End Cap Closed

3. End Cap w/Hole

3. End Cap Open